

vbOnline Pro Condition Monitoring System Datasheet

Bently Nevada Machinery Condition Monitoring

113M5326 Rev. E

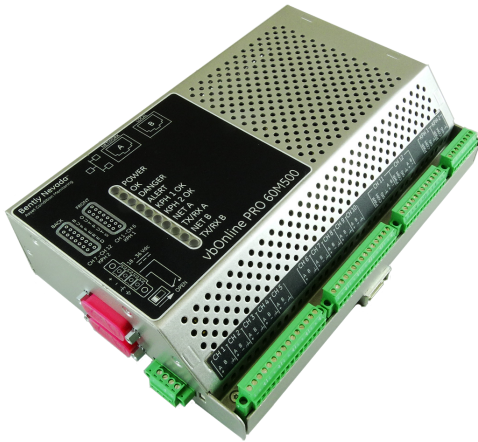

Description

The vbOnline Pro Condition Monitoring System uses sophisticated signal processing algorithms together with machinery operating states to monitor assets continuously. This system is part of a condition based maintenance program that identifies problems before assets begin to fail.

Benefits of the vbOnline Pro Condition Monitoring System are:

- Cost savings from reduced machinery down time
- Early detection of bearing defects
- Reduction of damage to assets

The monitoring system's key features are:

- Signal conditioning
- Alarming
- Speed inputs
- Control system communication

The vbOnline Pro Condition Monitoring System communicates with System 1 via dual Ethernet connections. The monitoring system uses 24 bit analog/digital conversion and 40 kHz bandwidth to monitor rolling element bearing machinery and gearing.

Sophisticated signal processing algorithms extract measurement and health indices from each accelerometer point. The algorithms can be custom tuned to specific bearing and gear box characteristics.

The vbOnline Pro Condition Monitoring System exports trended measurements like direct, bias, speed, gap as well as channel NOT OK status to third party systems such as DCS via Modbus over ethernet.

The vbOnline Pro Condition Monitoring System components are the vbOnline Pro monitor, System 1, Bently Nevada Monitor Configuration software, transducers, and cables.



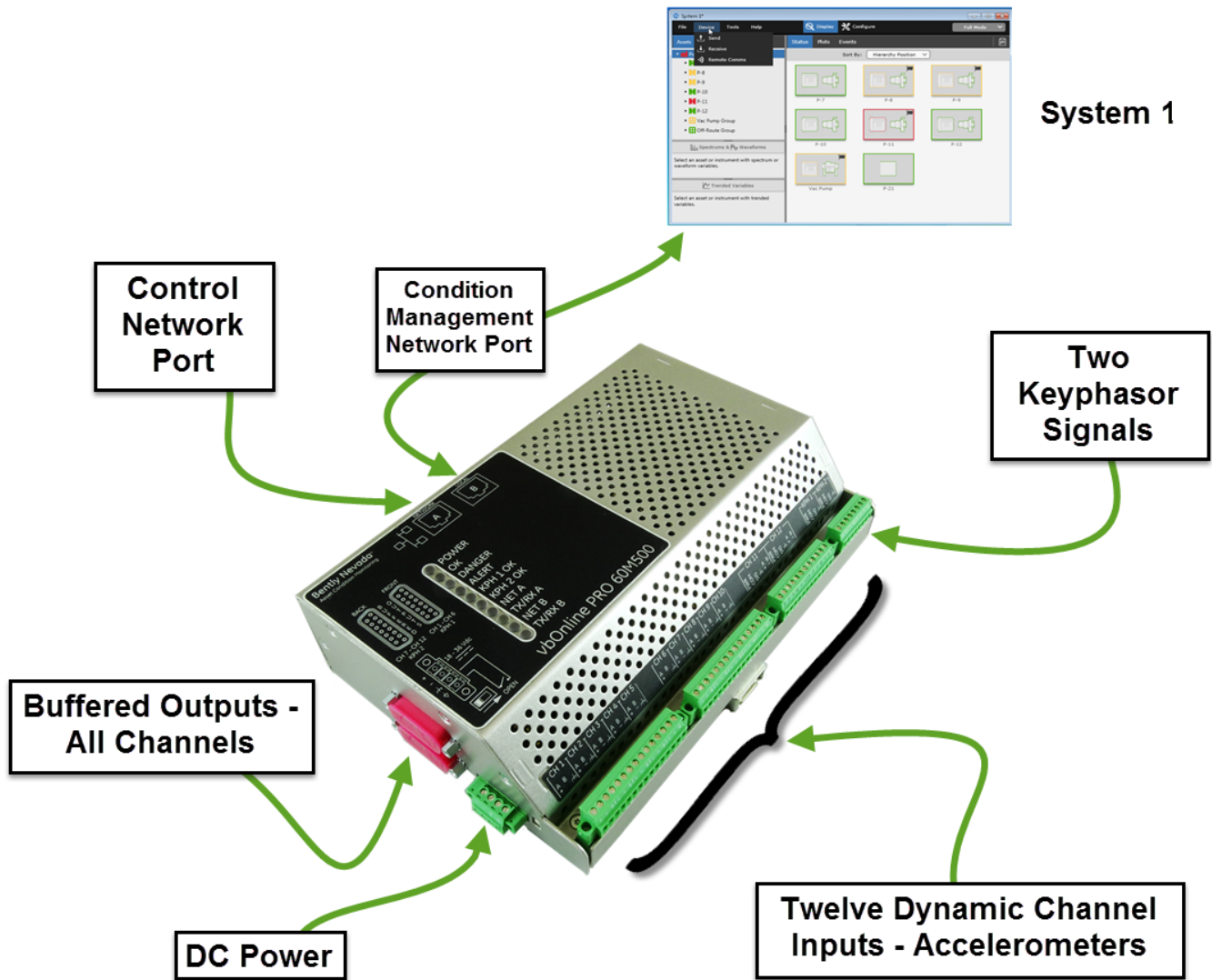

Figure 1: vbOnline Pro Condition Monitoring System Components

Specifications

Electrical Specifications

Inputs

Minimum Input Power	18 Vdc
Maximum Input Power	36 Vdc
Maximum Current	1.7 A
Maximum Inrush Current	2.7 A Less than 5 ms
Maximum Inputs	12 dynamic signals 2 Keyphasor signals
Dynamic Range	110 dB @ fs = 102.4 ksps
Signal/Noise Ratio	110 dB @ fs = 102.4 ksps
A/D Conversion	Sigma-Delta 24 bits nominal
Bandwidth	0 to 40kHz

Outputs

Buffered Signal Outputs	Two 15 pin DSUB connector 550 ohm output impedance
-------------------------	--

Two Independent Ethernet Ports

Network A	10/100BaseT Network DHCP Port
Network B	10/100BaseT Local Static IP Port

LEDs

Power LED	Indicates when a proper power input is present
OK LED	Indicates when the system is functioning properly
Danger LED	Indicates a Danger Alarm condition
Alert LED	Indicates an Alert condition
Kph 1 OK LED	Indicates Keyphasor signal 1 is triggering
Kph 2 OK LED	Indicates Keyphasor signal 2 is triggering
Net A	Indicates Network A has a valid link
TX/RX A	Indicates network traffic is flowing on Network A

Net B	Indicates Network B has a valid link
TX/RX B	Indicates network traffic is flowing on Network B

Accuracy

Direct pk or rms	± 1.1%
Bias	+0.8 V / -1.34 V

Dynamic Data

Configurable Synchronous Waveforms	Up to 8192 samples
Spectral Lines	100 to 12,800 in increments of 2X
Spectrum Frequency Range	User Configurable up to 40 kHz
Supported Frequency Range	0 Hz to 40,000 Hz
Spectral Resolution	100 to 12,800 in increments of 2X
Spectrum Window Types	Hanning
Demodulation Bandwidth	125 Hz to 10 kHz 18 preset options
Update Rate	Up to once every 10 minutes User configurable
Data Storage	8 hours Typical No alarms

Keyphasor Signal Inputs

Speed Range	1 to 120,000 rpm
Speed Accuracy	1 to 100 rpm ± - 0.1 rpm 100 to 10,000 rpm ± 1 rpm 10,000 to 120,000 rpm ± 0.01%
Events per Revolution (EPR)	1 to 10,000
Input Frequency	0.0167 Hz to 5 KHz
Auto Threshold	Use for any input above 3 rpm for 1 event/revolution. Keyphasor Pulse Width must be greater than or equal to 10 micro-seconds.
Manual Threshold	User selectable from +3V to -22V Use for any input above 1 rpm for 1 event/revolution. Keyphasor Pulse Width must be

	greater than or equal to 6 micro-seconds.
Signal Amplitude	Minimum 5 Vpp for pulse-width less than 10 micro-seconds and greater than or equal to 6 micro-seconds. Minimum 2 Vpp for pulse-width greater than 10 micro-seconds.
Signal Range	Supported signal range +4V to -23V.
Hysteresis	User selectable from 0.2 to 10 volts.

Supported Transducers

Acceleration Channels	Compatible with constant current accelerometers
Keyphasor Channels	Proximity switches such as Turck Ni8-M18T-AP6X7M Bently Nevada Proximity Probes

Physical

Dimensions	8.88 X 5.89 X 2.17 inches 225 X 150 X 55 mm See "Graphs and Figures" on page 7.
Weight	1.4 kg 3 lbs
Mounting	DIN Rail Mounting

Environmental Limits

Operating Temperature Range	-40 °C to +70 °C -40 °F to 158 °F
Storage Temperature Range	-45 °C to +85 °C -49 °F to 185 °F
Relative Humidity	0% to 95% non-condensing for operation and storage
Pollution Degree	Pollution Degree 2 Working voltage < 30 Vrms or 60 Vdc

Compliance and Certifications

 For a detailed listing of country- and product-specific approvals, refer to the *Approvals Quick Reference Guide* (document 108M1756), at Bently.com.

EMC

EMC	<p>Standards EN 61000-6-2 Immunity for Industrial Environments EN 61000-6-4 Emissions for Industrial Environments</p> <p>Directives 2014/30/EU</p>
-----	---

Electrical Safety

Electrical Safety	<p>Standards: EN 61010-1</p> <p>Directives 2014/35/EU</p>
-------------------	---

Hazardous Area Approvals

 For a detailed listing of country- and product-specific approvals, refer to the *Approvals Quick Reference Guide* (document 108M1756), at Bently.com.

CSA/NRTL/C	<p>Class I, Zone 2 AEx nA IIC T4 Gc Class I, Division 2 Groups A, B, C and D</p> <p>Install per drawing 115M4822</p> <p>T4 @ Ta = -40 °C ≤ Ta ≤ +70 °C</p>
ATEX/IECEX	<p> II 3 G Ex nA IIC T4 Gc Ex ec IIC T4 Gc</p> <p>Install per drawing 115M4822</p>

T4 @ Ta = -40 °C ≤ Ta ≤ +70 °C

SPECIFIC CONDITIONS OF USE:

1. The device shall be installed in an additional enclosure that provides an ingress protection rating not less than IP54 and meets the enclosure requirements of IEC 60079-0.
2. The equipment shall only be used in an area of not more than pollution degree 2, as defined in IEC 60664-1.
3. Transient protection shall be provided that is set at a level not exceeding 140% of the peak rated voltage value at the supply terminals to the equipment.
4. Tightening torque range is 2.0 in-lbf [0.22 N-m] minimum / 2.2 in-lbf [0.25 N-m] maximum.

WARNING

HAZARDOUS ENVIRONMENT

DO NOT DISCONNECT OR OPEN EQUIPMENT UNLESS POWER HAS BEEN SWITCHED OFF OR THE AREA IS KNOWN TO BE NON-HAZARDOUS.

Ordering Information



For the detailed listing of country and product specific approvals, refer to the *Approvals Quick Reference Guide* (108M1756) available from www.Bently.com.

60M500 - AA - BB

A: Agency Approvals

00	None
05	Multi Approvals (CSA, IECEx, ATEX)

B: System 1 License

00	None
01	One

Sensors and Cables

Part Number	Description
AS3100S2-Z2	Accelerometer, Side Exit 100 mV/g 0.7 - 10,000 Hz
AM3100T2-Z	Accelerometer, Top Exit 100 mV/g, 0.4 - 14,000 Hz
AP3500T2-Z1	Accelerometer, Top Exit 500 mV/g, 0.2 - 2,300 Hz
AP3500S2-Z1	Accelerometer, Side Exit 500 mV/g, 0.2 - 3,700 Hz See 3300 XL NSV Proximity Transducer System datasheet, document 147385, and 3300 XL 8mm Proximity Transducer System datasheet, document 141194.
330780	3300 XL 11mm Proximity Transducer System
330180	3300 XL 8mm Proximity Transducer System
330980	3300 XL NSV Proximity Transducer System
200355	Low Frequency Accelerometer 100 mV/g 0.2 - 10,000 Hz
287844	Accelerometer Mounting Stud 1/4 -28 to M8x1.25 SST
284613-050	Accelerometer Cable 15.2 m (50 ft) with straight connector

Part Number	Description
284613-030	Accelerometer Cable 9.1 m (30 ft) with straight connector
284622-050	Accelerometer Cable 15.2 m (50 ft) with right angle connector
284622-030	Accelerometer Cable 9.1 m (30ft) with right angle connector
138131	CAT5 Cable Minimum cable length is 3 feet. Maximum cable length is 320 feet. Cable lengths are 3, 6, 10, 25, 40, 50, 75, 85, 100, 120, 150, 200, 250 and 320 feet.
323314-01	Buffered output cable 15-pin DSUB to 7 SMA connectors
323314-02	Buffered output cable 15-pin DSUB to 7 BNC connectors

Accessories

100M9465-01	Bently Nevada Monitor Configuration Software DVD BNMC Software is included with vbOnline Pro Condition Monitoring System for user administration, IP configuration and firmware updates.
-------------	---

Miscellaneous

104M2708-01	Spare Power Input Connector
104M3960-01	Spare Input Connector Ch 1-10
104M3961-01	Spare Input Connector Ch 11-12
104M3962-01	Spare Input Connector KPH 1-2

Graphs and Figures

Dimensions shown are in inches (millimeters)

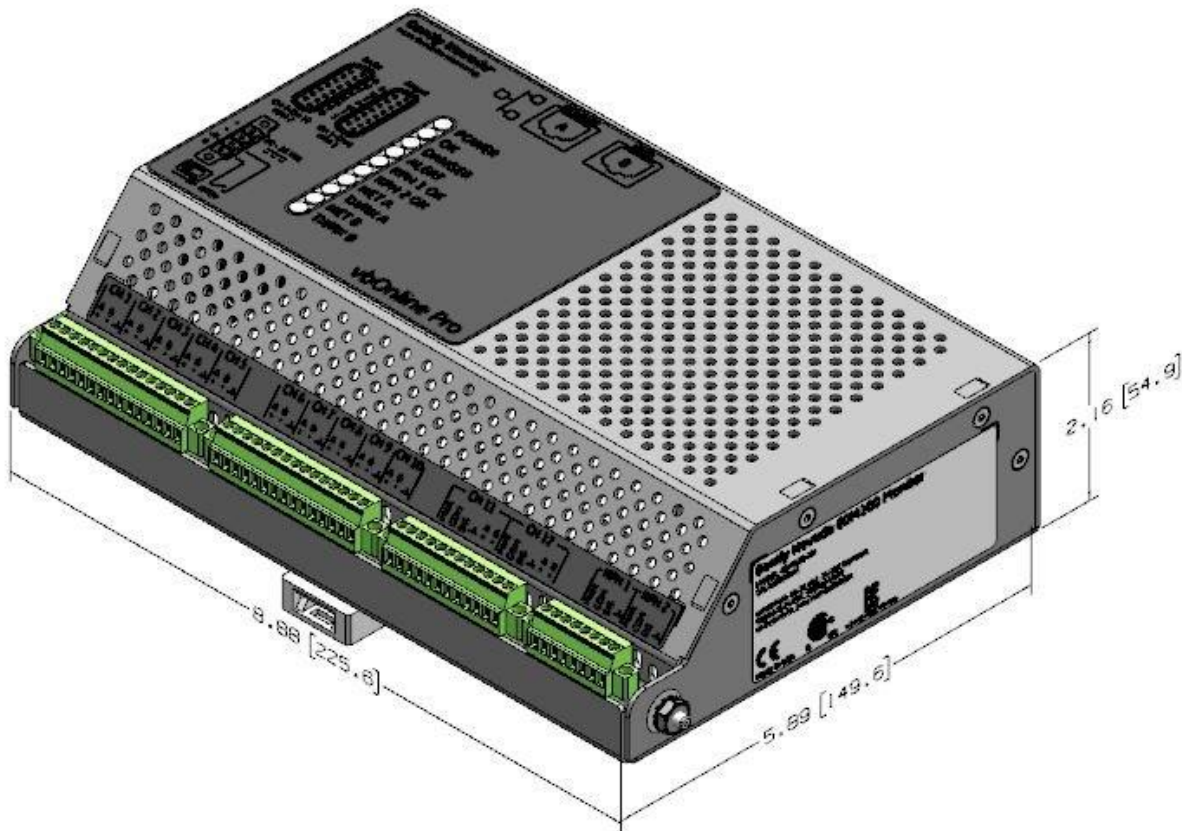

Figure 1: vbOnline Pro

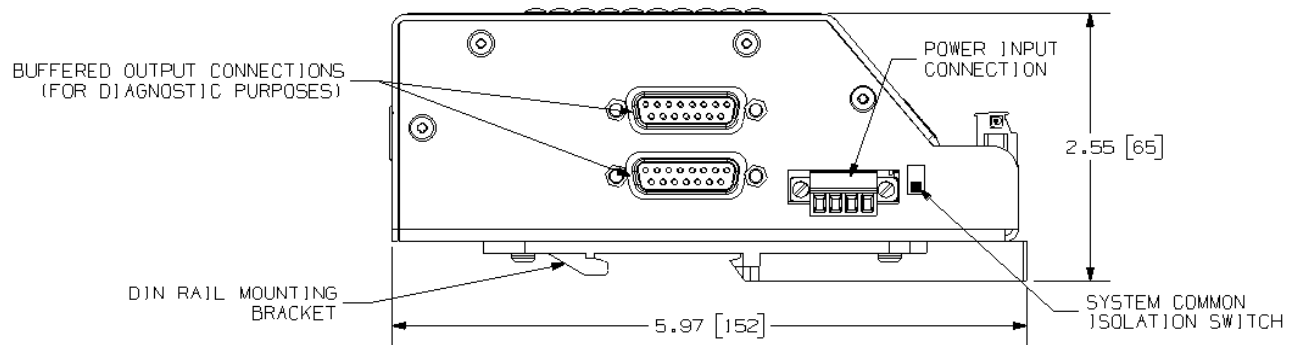

Figure 2: vbOnline Pro - Side View

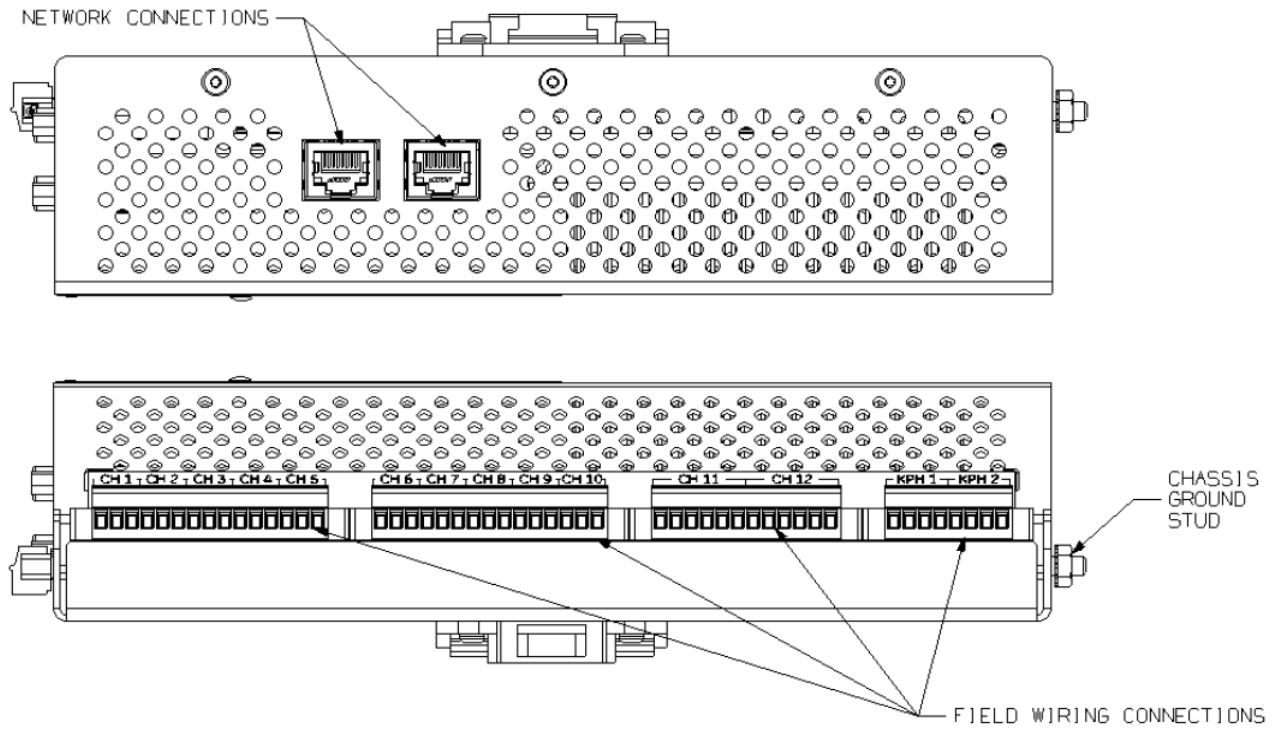

Figure 3: vbOnline Pro - Top and Bottom Views

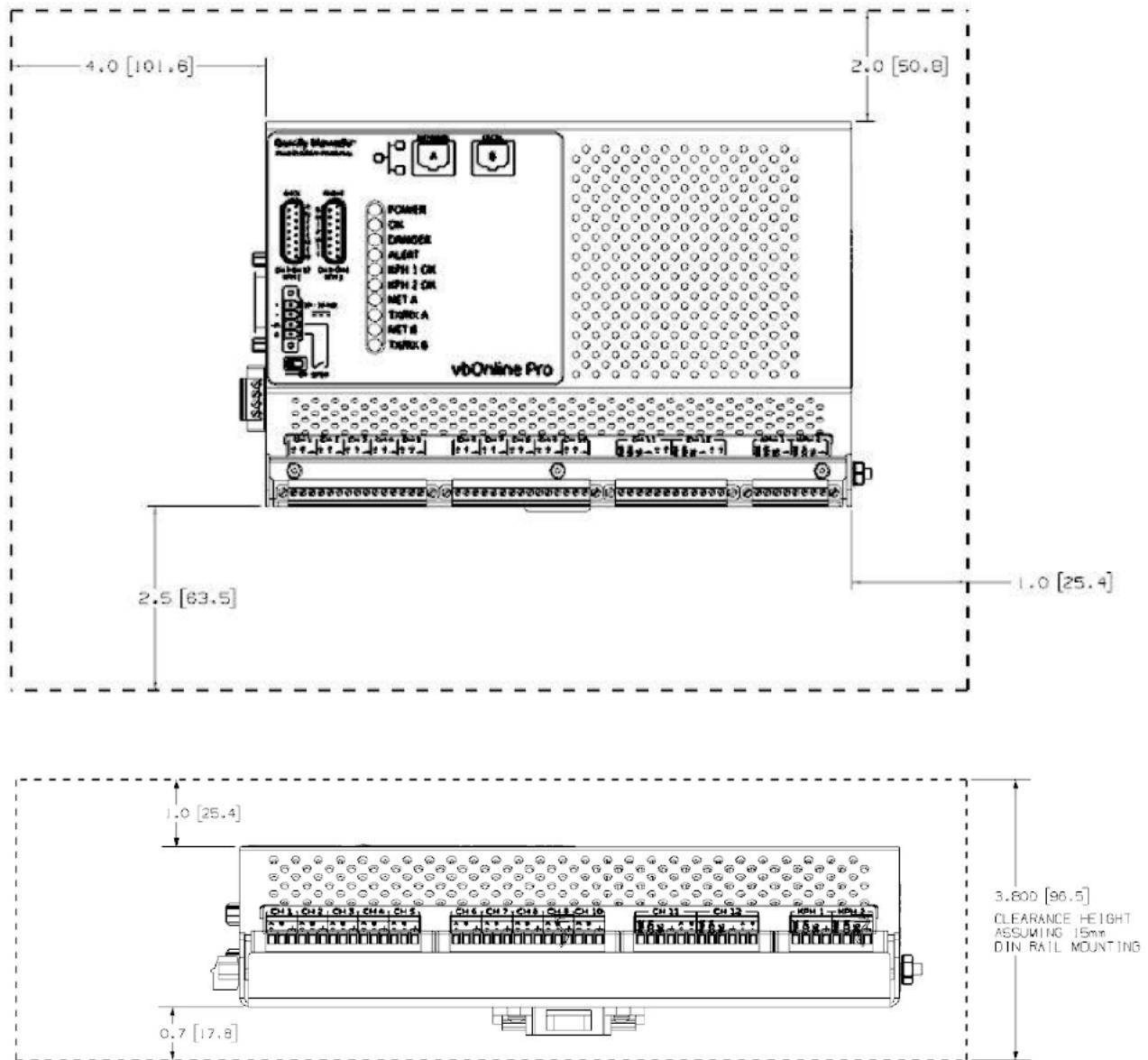

Figure 4: Recommended Minimum Clearance Window for Cable Terminations and Monitor Cooling

Copyright 2019 Baker Hughes Company. All rights reserved.



Bently Nevada, Orbit Logo, vbOnline, Keyphasor and System 1 are registered trademarks of Bently Nevada, a Baker Hughes Business, in the United States and other countries. The Baker Hughes logo is a trademark of Baker Hughes Company. All other product and company names are trademarks of their respective holders. Use of the trademarks does not imply any affiliation with or endorsement by the respective holders.

Baker Hughes provides this information on an "as is" basis for general information purposes. Baker Hughes does not make any representation as to the accuracy or completeness of the information and makes no warranties of any kind, specific, implied or oral, to the fullest extent permissible by law, including those of merchantability and fitness for a particular purpose or use. Baker Hughes hereby disclaims any and all liability for any direct, indirect, consequential or special damages, claims for lost profits, or third party claims arising from the use of the information, whether a claim is asserted in contract, tort, or otherwise. Baker Hughes reserves the right to make changes in specifications and features shown herein, or discontinue the product described at any time without notice or obligation. Contact your Baker Hughes representative for the most current information.

The information contained in this document is the property of Baker Hughes and its affiliates; and is subject to change without prior notice. It is being supplied as a service to our customers and may not be altered or its content repackaged without the express written consent of Baker Hughes. This product or associated products may be covered by one or more patents. See [Bently.com/legal](https://www.bently.com/legal).

1631 Bently Parkway South, Minden, Nevada USA 89423
Phone: 1.775.782.3611 or 1.800.227.5514 (US only)
[Bently.com](https://www.bently.com)